

HD DRONE

HD Foldable Pocket Drone

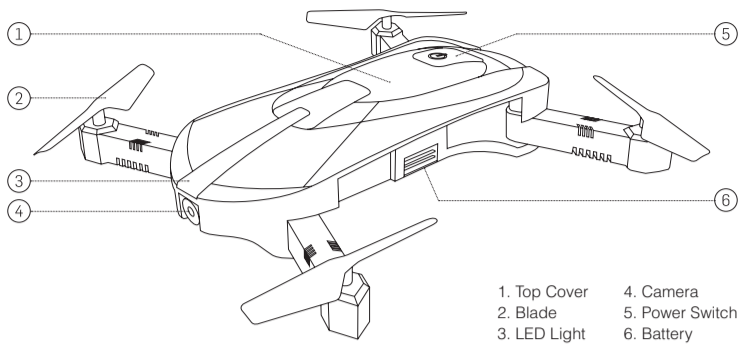

- 1. Top Cover
- 2. Blade
- 3. LED Light
- 4. Camera
- 5. Power Switch
- 6. Battery

IMPORTANT SAFETY INFORMATION

CAUTION: AVOID FLYING DRONE IN CROWDED AREAS.

WARNING: NOT SUITABLE FOR CHILDREN. ROTATING BLADES MAY CAUSE INJURY.

Important Instructions Before Use

1. Only use device for intended purposes.
2. Fly drone in area without low barriers or crowds of people.
3. Review rules and regulations for flying drones in your area.
4. Ensure all propellers are secure.

Pre-Flight Preparation

1. Propeller installation

Propellers should be installed by partnering with their corresponding leg. Please see the diagram on the right for details. Failure to install propellers correctly may impact drone performance. To install and uninstall propellers, use the included screwdriver.

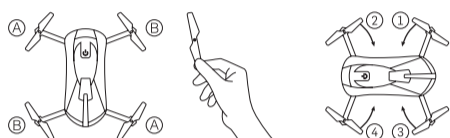

2. Arm folding order

When storing, fold the front arms (near the camera) in first.

3. Lithium battery instructions

Grip the battery from both sides and pull out the entire battery assembly. To charge, plug the USB cable into a power source and the red cable into the battery.

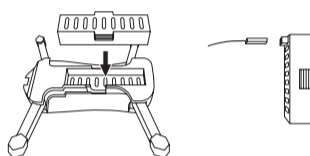

App Instructions

Download Drone App on Your Smart Device

1. Scan QR code for your Android or iOS device.



Android



iOS

Android (Google Play): https://play.google.com/store/apps/details?id=com.lewei.jyufu&hl=en_US
 iOS (App Store): <https://itunes.apple.com/us/app/jy-ufo/id1146475731?mt=8>

2. Before use, place the drone on the flat ground. Turn on your Wi-Fi and connect to WiFi-720P-###.

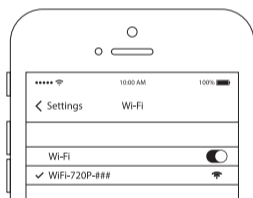

3. Open the app and enter main interface, then click "play" to enter the main app.



4. Click "Off" to enable the controls.

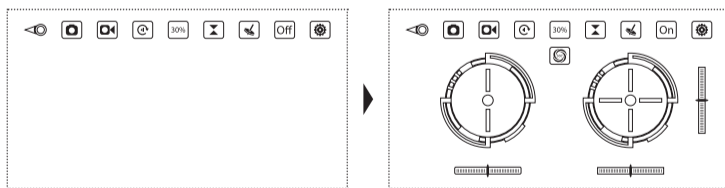

5. Click icon "X" to activate altitude hold.

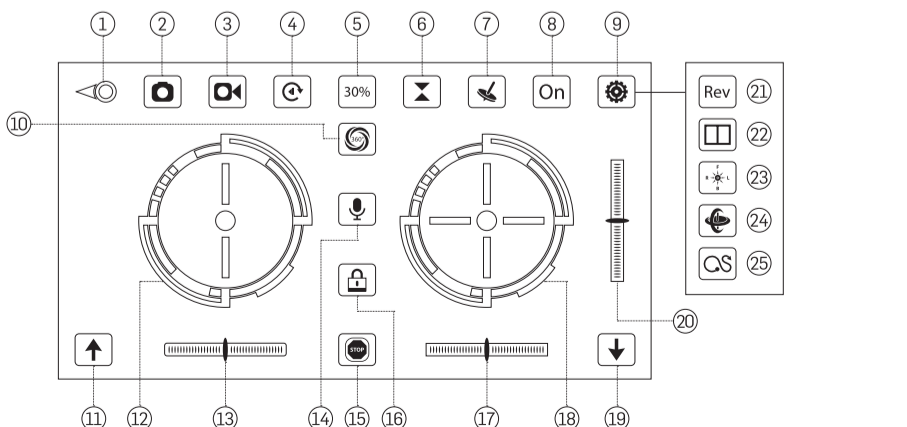

- 1. Main Menu
- 2. Capture Photo
- 3. Capture Video
- 4. View Photos/Videos
- 5. Speed
- 6. Altitude Hold
- 7. Gravity Sensor
- 8. Show/Hide Controls
- 9. More Settings
- 10. 3D Flips and Rolls
- 11. One-Key Takeoff
- 12. Left Joystick (Height/Turning)
- 13. Left/Right Rotation Fine-Tuning
- 14. Voice Control
- 15. Emergency Stop
- 16. A Key to Unlock
- 17. Left/Right Side Fly Fine-Tuning
- 18. Right Joystick (Strafing)
- 19. One Key Landing (Must Be on Ground)
- 20. Forward/Backward Fine-Tuning
- 21. Flip Camera View Vertically
- 22. Toggle 3D
- 23. Headless Mode
- 24. One-Key Calibration
- 25. Draw route

Operating Your Drone

1. Gravity Sensor Mode: Use this feature to control your drone by shaking your phone.

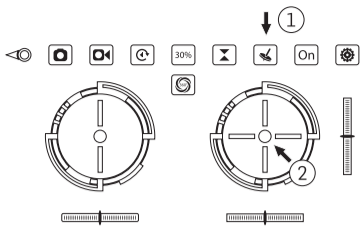

2. Take Pictures/Videos:

- Hold the drone in Altitude Mode.
- Position the drone to face forward.
- Click on the camera button or video button to capture photos/videos. Click video button again to stop recording.

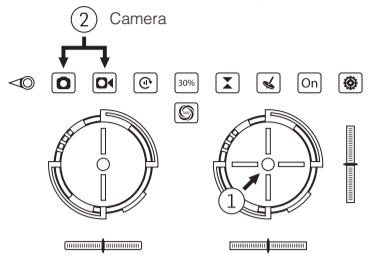

Tips for Operating Your Drone

⚠ Attention: After flight, please disconnect the battery from the drone to avoid battery damage.

- After charging, connect the battery with the drone. Place the drone on a level surface.
- Ensure there is enough space to safely fly your drone. Make sure you are aware of which way the drone is pointing before takeoff to ensure easier flying.

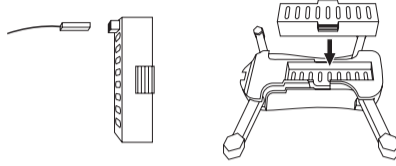

⚠ Attention: The camera of your drone is the "front".

Push up on the left joystick to ascend, and push down on the joystick to descend.

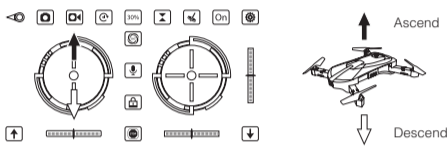

Push the left joystick to the left and right to rotate the direction that the drone is facing.

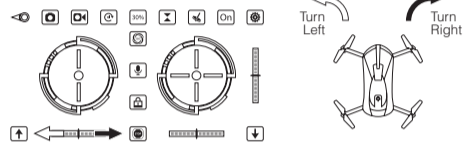

Push up on the right joystick to fly forward, and push down on the joystick to fly backward.

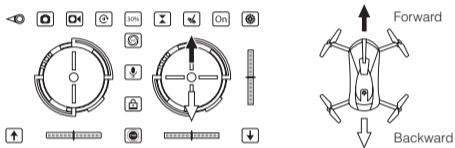

Push left and right on the right joystick to strafe the drone left and right (it will slide directly to the left or right without rotating).

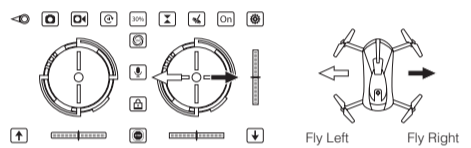

⚠ Attention: The left joystick should be used carefully to slowly ascend. You may use the fine-tuning function to calibrate your drone as necessary.

If the drone rotates clockwise on its own while hovering, adjust the fine-tuning to the right until it returns to normal.

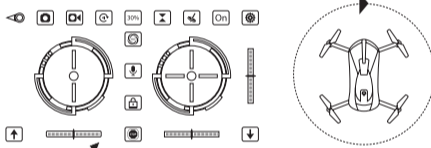

If the drone rotates counterclockwise on its own while hovering, adjust the fine-tuning to the left until it returns to normal.

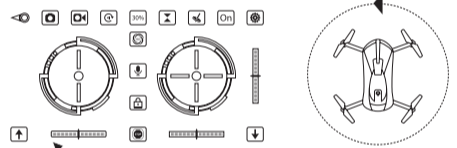

If the drone drifts to the left while flying, adjust the fine-tuning to the right until it returns to normal.

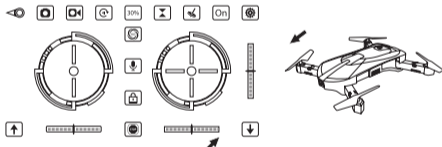

If the drone drifts to the right while flying, adjust the fine-tuning to the left until it returns to normal.

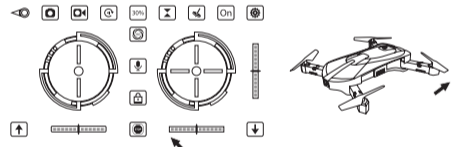

If the drone drifts to forward while flying, adjust the fine-tuning to the forward until it returns to normal.

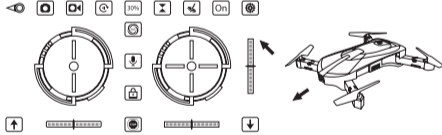

If the drone drifts to backward while flying, adjust the fine-tuning to the backward until it returns to normal.

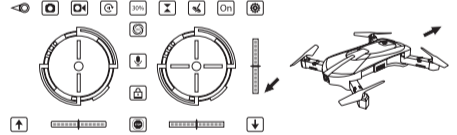

⚠ Attention: When your drone is within one foot of the ground, the vortex generated by the propellers will make it become unstable. Flying higher will alleviate this problem.

1. Recommended Flying Conditions

- Indoor flying: Choose a wide place without barriers, pets, people, or items that could be damaged.
- Outdoor flying: Choose a warm, clear, windless day.
 - Do not fly in extreme temperatures. Flying in extreme temperatures may affect the performance and damage the product.
 - Do not fly in windy days. The performance and the control of the drone will be affected by the strong winds. Flying in overly windy conditions may damage or destroy the drone, and may cause the drone to fly away.

2. Fundamental flying

We recommend flying in a square, trying to go in a cross-shaped pattern, or going in a circle after mastering takeoffs, landings, and basic rotation.

3. Altitude Hold

When you release the left joystick after reaching your desired height, the drone will still hover over the height when the joystick was released.

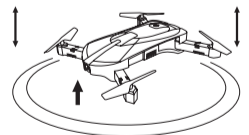

⚠ Use Emergency stop if drone is flying in uncontrollable or unsafe conditions.

Caring Information

⚠ If unit needs cleaning, wipe with damp cloth. Do not attempt to clean with liquid cleansers or submerge in water.

Technical Specifications

| | |
|-----------------------------|--|
| Dimensions | 250 x 250 x 35 mm |
| Weight | 85 g |
| Color | Black, turquoise |
| Battery Life | 6-8 minutes |
| Charging Time | 70 minutes |
| Main Material | ABS & Hardware |
| Controller | Mobile Wi-Fi control |
| Gyroscope | 6-Axis |
| Motor type | Coreless motor |
| Function | Forward/backward, up/down, left/right sideways flight, hovering, 3D flip, headless mode, high/low speed, one-key landing, FPV image transmission, photo taking and video recording, altitude hold. |
| Number of Cameras Included | 1 |
| Built-in Camera | Yes |
| Camera | 2MP |
| Video | 480p |
| Supported Operating Systems | Android 4.2 and iOS 7.0 above |

CE The device complies with the European Directives 2014/53/EU.

♻ At the end of its service life, this product may not be disposed of in the normal household waste, but rather must be disposed of at a collection point for recycling electrical and electronic devices. The materials are recyclable according to their labeling. You make an important contribution to protecting our environment by reusing, recycling, or utilizing old devices in other ways. Please ask the municipal administration where the appropriate disposal facility is located.

Subject to change.